

技术参数:  
 产品类型: 耳轴安装型  
 缸径: 63  
 活塞杆直径: 40  
 行程: 300  
 丝杆规格: 2005  
 安装电机型号: 80ST

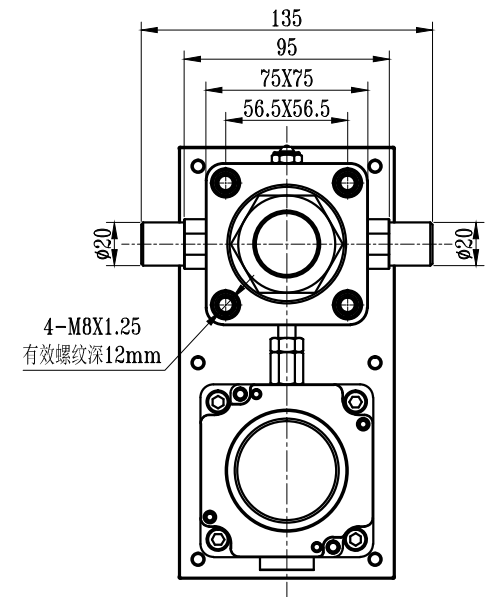

此处电机安装面板会根据电机规格来确认尺寸, 细节尺寸请参照3D